

DRAWING No.
K- F-C 2000

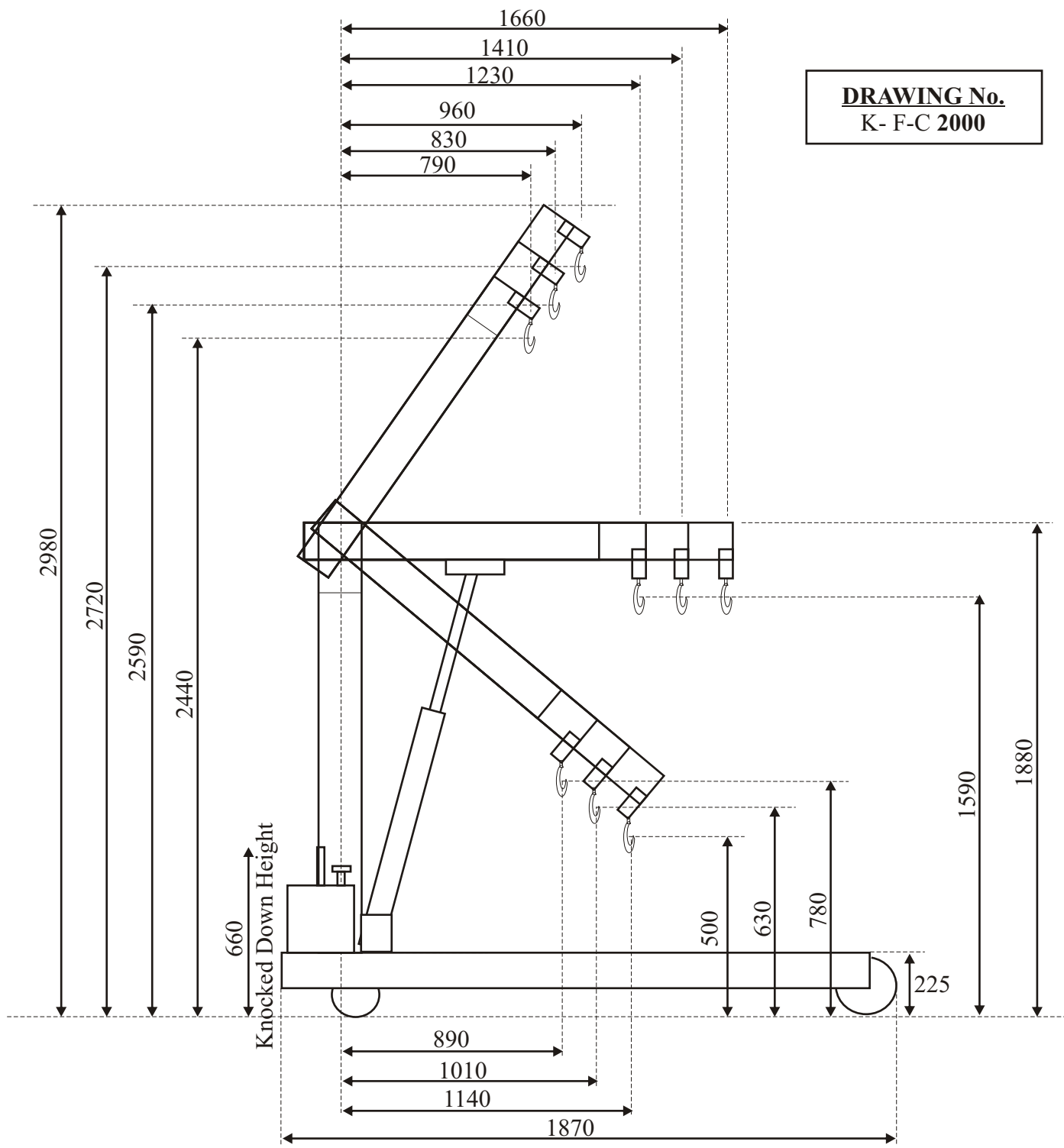
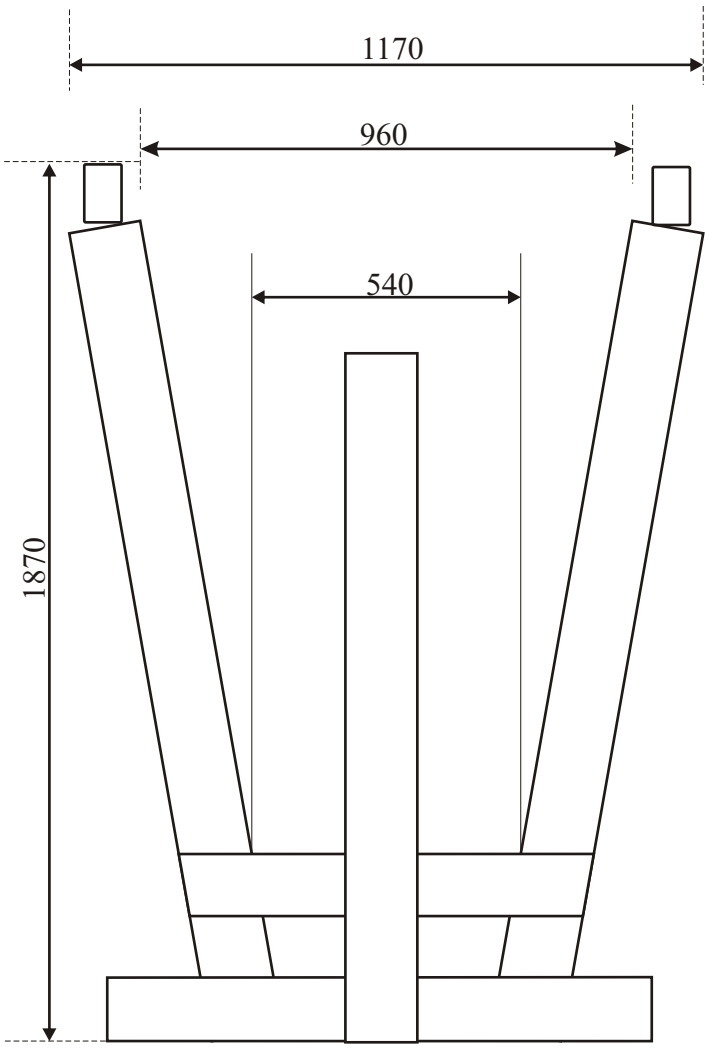

MAX. LOAD AT POSITIONS

	1	2	3
Kg	2000	1500	1000