

DRAWING No.
K- F-C 1000

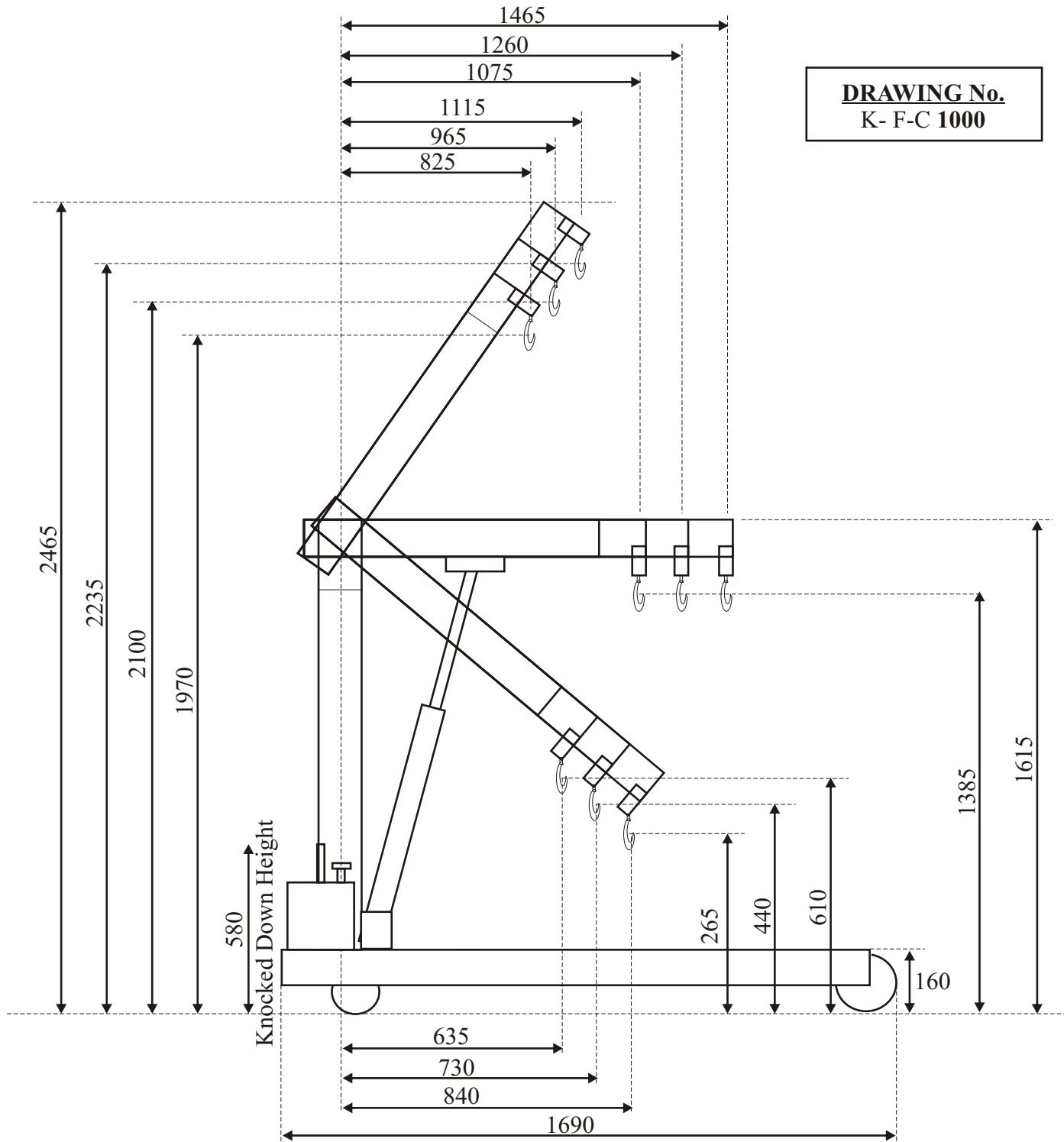
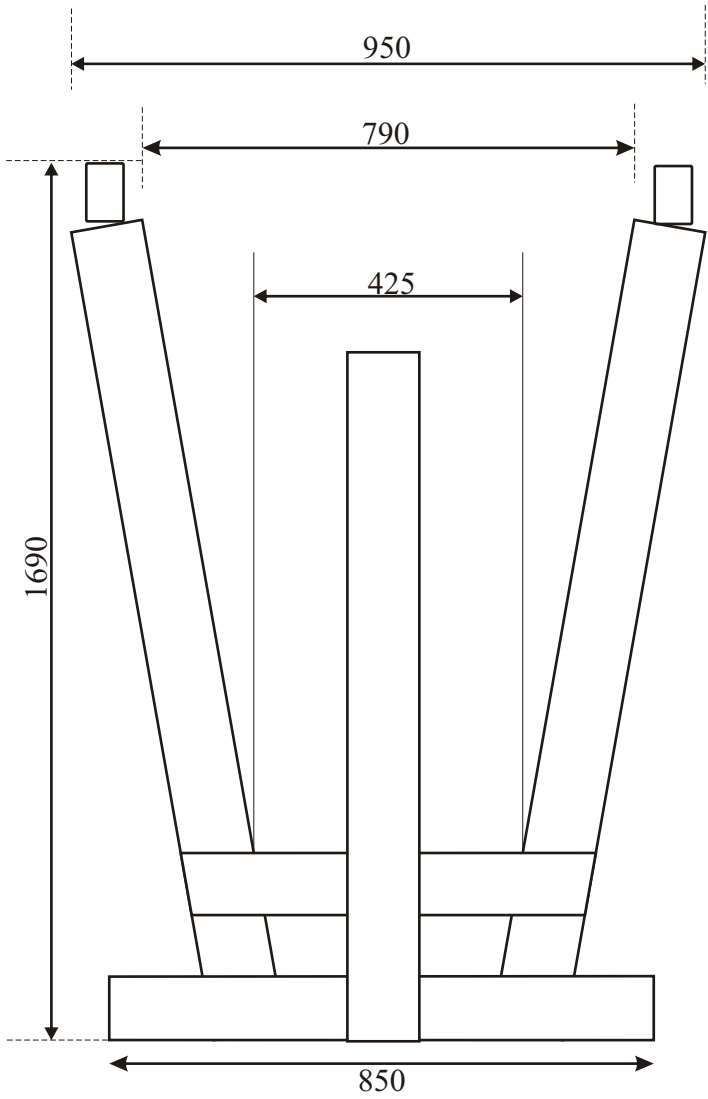

MAX. LOAD AT POSITIONS

	1	2	3
Kg	1000	750	500