

DRAWING No.
K- F-C 750

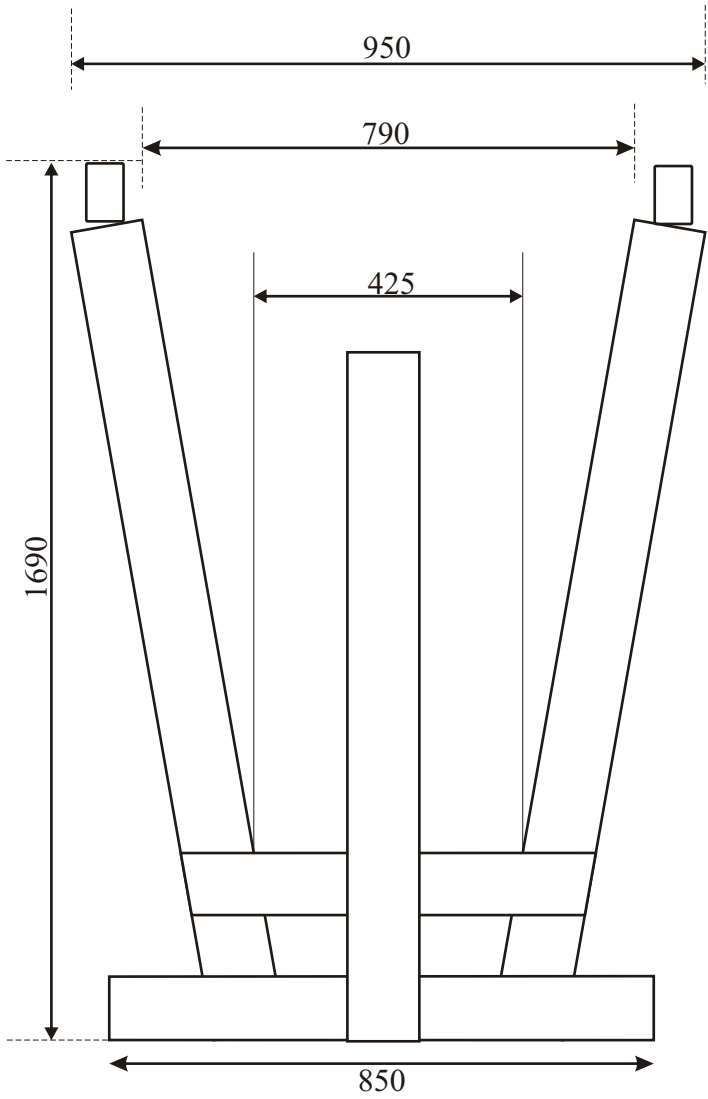

MAX. LOAD AT POSITIONS

	1	2	3
Kg	750	600	500

